

HTi⁷⁰

High temperature heat pumps
with a wide capacity modulation



BV Cert. 6020118*

The only heat pumps*
certified "Origine France Garantie"!

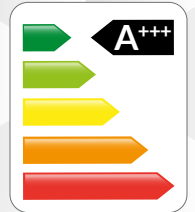

HIGH TEMPERATURE:
heating water up to **70°C**

WIDE CAPACITY MODULATION
from **15% to 100%**

HEATING CAPACITY increases as
the air temperature gradually lowers

Replace your boiler
by an HTi⁷⁰ heat pump,
reliable, robust and efficient !



HYDRAULIC PILOTS
for all types of installations:



AIR
SOURCE



HEATING



DOMESTIC
WATER

*only HTi⁷⁰ 6 & 8 single-phase concerned

(a) subject to compliance with the warranty conditions stipulated in our current Terms and Conditions.



Made in France

www.auer.fr

THE NEW RANGE OF

HTi⁷⁰

3 driver choices depending on the installation:

WIDE RANGE OF POWER:
6, 8, 11 & 14kW.

Available in single and three-phase

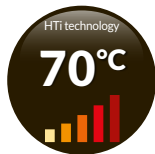
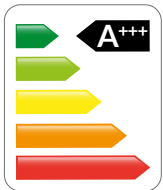

Easy monobloc heat pump to be installed using a simple hydraulic connection.



PRIMO Pilot

Compact and complete to manage simple installations

Installation example:
In a modern 100 sqm house equipped with high temperature radiators, HTi⁷⁰ 6 PRIMO is the best solution.



PREMIUM+ Pilot

Perfect for home renovations with many hydraulic connection possibilities.

Installation example:
In an old 120 sqm house equipped with 2 high temperature radiators circuits, HTi⁷⁰ 11 is the best substitute to an old fuel boiler which consumes 3000 liters per year.



DS 170D Pilot

Domestic hot water and heating

Installation example:
In a recent 160 sqm house equipped with radiators or underfloor heating, HTi⁷⁰ 8 with DS 170D and DHW included: full and stand-alone solution.

HIGH TEMPERATURE & ULTRA MOD

PRIMO Pilot



- Management of the heating and the domestic hot water
- Pre-connection for separate DHW tank (ex: PEJ tank)
- Equipped with an expansion vessel
- Programmable 3 kW electrical back-up
- Possibility of decoupling the heat pump circuit and the radiator circuit (decoupling set in option)

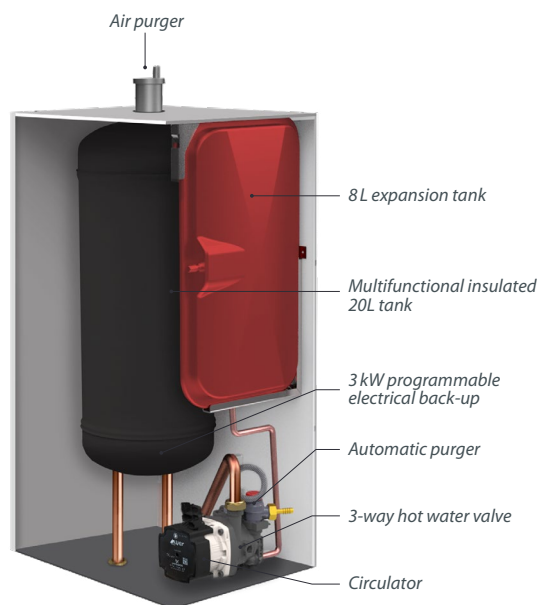

PREMIUM+ Pilot

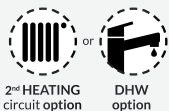

- Hydraulic decoupling tank (38L), degassing and decanting
- Direct pre-connection for an existing boiler
- 2nd heating or domestic hot water circuit possible
- Programmable electrical back-up (6 kW)

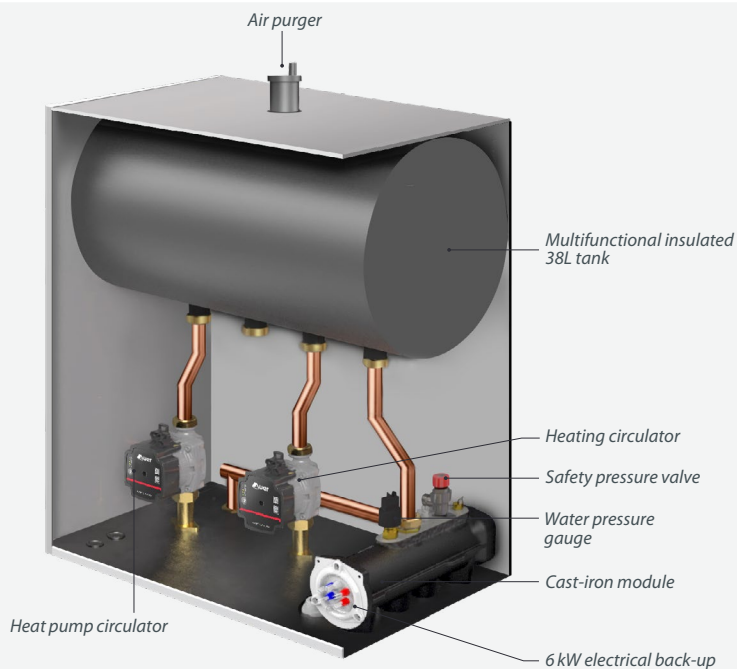

DS 170D Pilot



- Complete hydro-electronic pilot included in the DHW tank
- Equipped with an expansion vessel
- Cast-iron unit for programmable 3 kW electrical back-up
- A 170L DHW tank integrated
- Hydraulic decoupling of the circuits

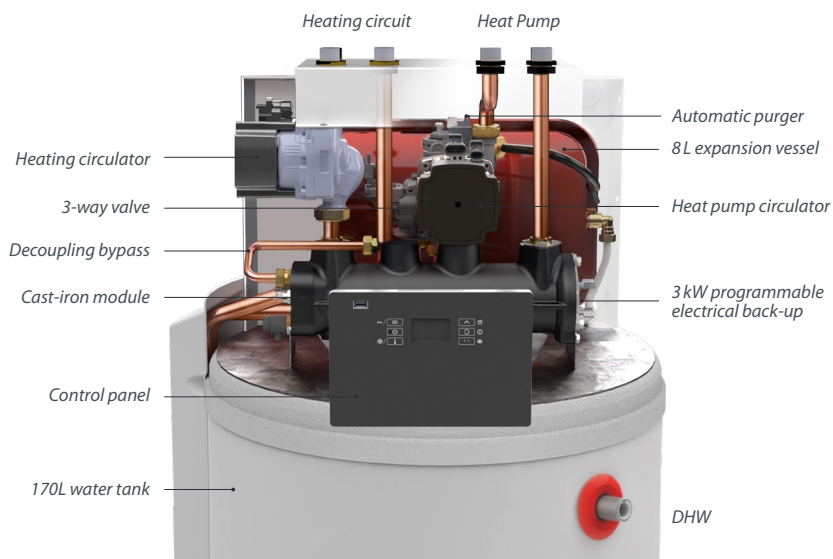

ULATING HEAT PUMPS

PRIMO pilot's operation

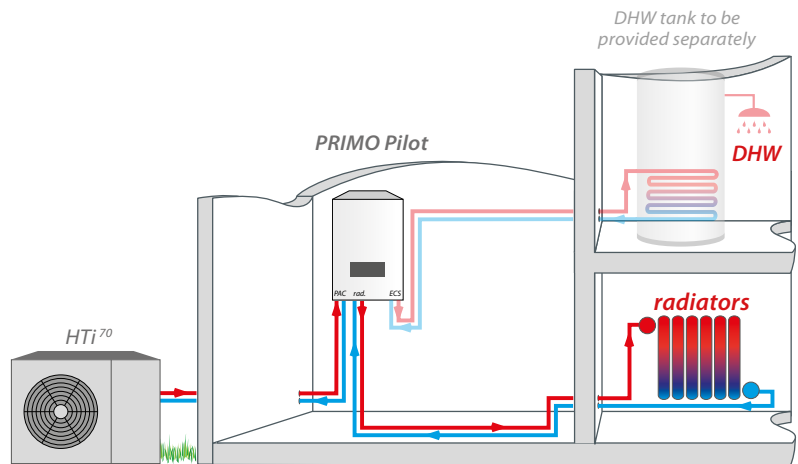
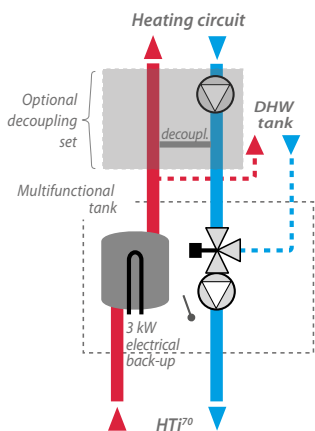

Schematic drawing: please refer to the installation manuals for the connection geometry

PREMIUM+ pilot's operation

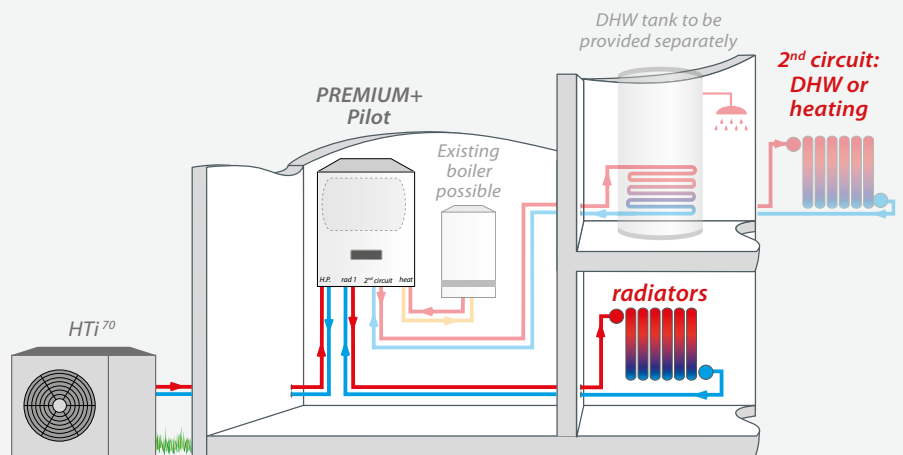
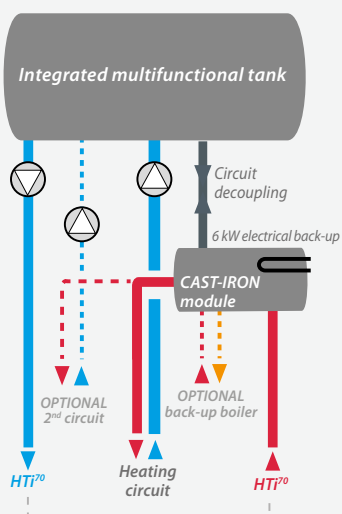

Schematic drawing: please refer to the installation manuals for the connection geometry

DS170D pilot's operation

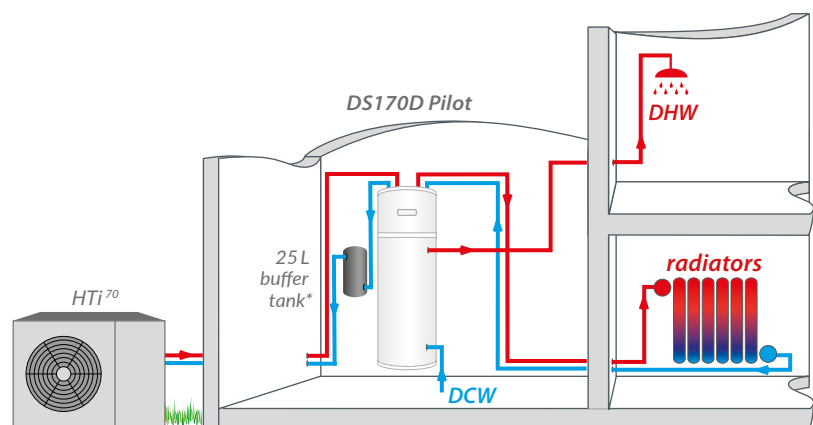
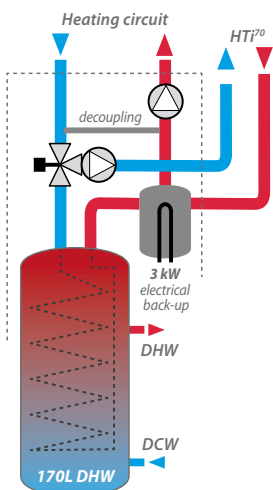

Schematic drawing: please refer to the installation manuals for the connection geometry

*Only for the HTi⁷⁰ 11 and 14 heat pumps.

WHY OPT FOR HTi⁷⁰?

The high temperature with a wide capacity modulation, and which does not lose its heating capacity in cold weather!



HOW DOES IT WORK?

CAPACITY ULTRA-MODULATION

 In mid-season, HTi⁷⁰ optimally adjusts both its capacity and temperature.

 In winter, HTi⁷⁰ delivers its full capacity at high temperatures to bring more comfort.

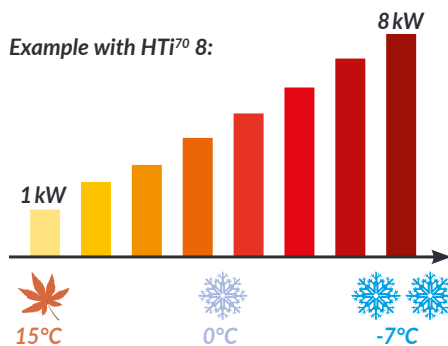

IN RENOVATION:

The 70°C high temperature is a guarantee of performance in every season. Thanks to its ability to raise water to high temperatures, the HTi⁷⁰ heat pump enables you to keep your existing radiators circuit while replacing your old fuel boiler.

 No need to replace your radiators! A simple electrical connection and hydraulic is enough.

FOR NEW BUILDINGS:

Thanks to its ultra-modulation, HTi⁷⁰ can easily adapt to the low heating needs required in new buildings. Moreover, this heat pump is able to rise to high temperatures in order to supply the necessary DHW without any electrical back-up, even in cold weather.

- Thanks to its ultra-modulation, HTi⁷⁰ can adapt its capacity to the heating needs and set the accurate temperature of the radiators.
- Guaranteed savings thanks to an outstanding seasonal COP.

EASIEST INSTALLATION

- **Very easy to set-up:** no gas connection; just a hydraulic connection!
- **More savings on the electrical installation:** its low power consumption allows a simple power supply of 16A^(a).
- **Conservation of the existing heating circuit** (radiators or underfloor heating).
- **Designed to heat new or existing buildings.**
- **Easy condensation drainage** thanks to its connecting hole.
- **Optional adjustable foot set:** very useful to install the heat pump properly on uneven grounds. Also useful in snowy areas. See picture below.
- **Pre-assembled transport straps included.** See picture below.

^(a) 32A for HTi⁷⁰ 11 and 14 heat pumps

TECHNOLOGY:

Designed in the same vein as the HRC⁷⁰ Heat Pump:

- 70°C high temperature,
- Same outdoor monobloc unit and same indoor hydraulic pilot,
- A long-lasting design,
- The use of the R290 without HFC for a greater respect of our planet.

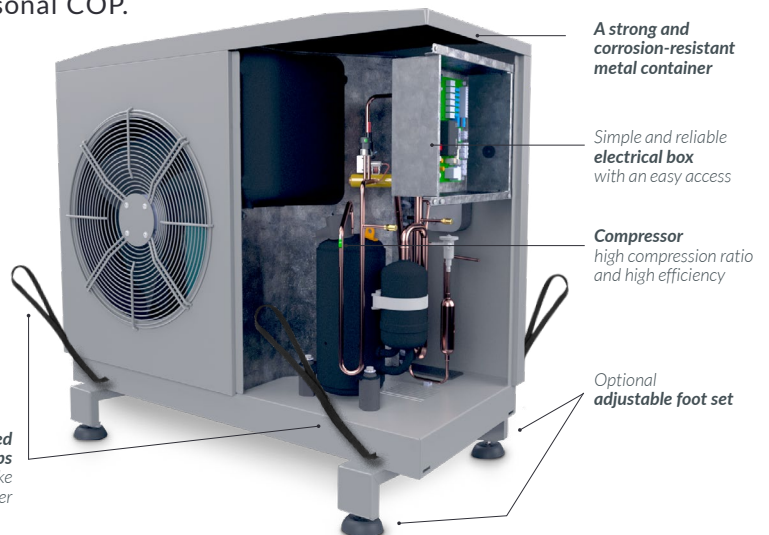

^(a) Subject to compliance with the warranty conditions stipulated in our current Terms and Conditions.

TECHNICAL SPECIFICATIONS

	HTi ⁷⁰ 6 single-phase	HTi ⁷⁰ 8 single-phase	HTi ⁷⁰ 8 three-phase	HTi ⁷⁰ 11 single-phase	HTi ⁷⁰ 11 three-phase	HTi ⁷⁰ 14 single-phase	HTi ⁷⁰ 14 three-phase
HTi ⁷⁰ + PRIMO Pilot	155001	155011	155051	155027	155067	155037	155077
HTi ⁷⁰ + PREMIUM+ Pilot	155006	155016	155056	155026	155066	155036	155076
HTi ⁷⁰ + DS 170D Pilot	155004	155014	155054	155024	155064	155034	155074

HEAT PUMP		HTi ⁷⁰ 6 single-phase	HTi ⁷⁰ 8 single-phase	HTi ⁷⁰ 8 three-phase	HTi ⁷⁰ 11 single-phase	HTi ⁷⁰ 11 three-phase	HTi ⁷⁰ 14 single-phase	HTi ⁷⁰ 14 three-phase
Energy class 35°C/55°C		A+++ / A++	A+++ / A+++	A+++ / A+++	A+++ / A++	A+++ / A++	A+++ / A++	A+++ / A++
Seasonal energy efficiency 35°C/55°C	η _s	187 % / 133 %	198 % / 154 %	198 % / 154 %	177 % / 126 %	177 % / 126 %	176 % / 125 %	176 % / 125 %
SCOP at 35°C/55°C	-	4,75 / 3,4	5,02 / 3,92	5,02 / 3,92	4,5 / 3,2	4,5 / 3,2	4,5 / 3,2	4,5 / 3,2
Maximum heating capacity at -7°C/35°C	kW	6	8	8	11	11	14	14
Maximum heating capacity at -7°C/65°C	kW	4,17	6,06	6,06	11	11	13	13
Nominal heating capacity at +7°C/+35°C (EN14511)	kW	5,05	4,85	5,01	9,14	9,14	11,21	11,21
COP at +7°C/+35°C nominal (EN14511)	-	5,05	5,35	5,35	5,02	5,02	4,89	4,89
Nominal sound pressure level (at 5m directivity 4)	dB(A)	38,1	41,6	41,6	42,3	42,3	in progress	in progress
Sound power level (ERP +7°C/55°C)	dB(A)	55,8	57,6	57,6	50,4	50,4	in progress	in progress
Outdoor air temperature range	°C	-20 to +40	-20 to +40	-20 to +40	-20 to +40	-20 to +40	-20 to +40	-20 to +40
Power supply	V	230 single	230 single	400 three-phase	230 single	400 three-phase	230 single	400 three-phase
Protection circuit-breaker	A	16 single	16 single	10 three-phase	32 single	16 three-phase	32 single	16 three-phase
Maximum electric power	kVA	3,6	3,6	3,6	7	7	7	7
Power cable cross-section	mm ²	3G 2,5	3G 2,5	5G 2,5	3G 6	5G 2,5	3G 6	5G 2,5
Dimensions (HxLxP)	mm	820x1035x450	1075x1035x450	1075x1035x450	1075x1235x490	1075x1235x490	1075x1235x490	1075x1235x490
Weight when empty	kg	81	94	108	136	146	142	150
Nominal water flow	L/h	1000	1350	1350	1550	1550	2000	2000
Refrigerant fluid	kg	R290 / 0,42	R290 / 0,6	R290 / 0,6	R290 / 0,9	R290 / 0,9	R290 / 0,95	R290 / 0,95
Hydraulic connections	mm	26/34 male	26/34 male	26/34 male	26/34 male	26/34 male	26/34 male	26/34 male

PILOT		PRIMO	PREMIUM+	DS 170D
Minimum power cable width	mm ²	3x2,5 (single)	3x6 (single) 5x2,5 (three-phase)	3x2,5 (single)
Circuit breaker	A	16	32 (single) 16 (three-phase)	16
Power supply	V	230 (single)	230 (single) 400 (three-phase)	230 (single)
Multifunctional tank	L	18	38	25*
Dimensions of the pilot (HxLxP)	mm	837x400x340	789x590x420	1725x571x542
Weight of the pilot without water	kg	30	47	80
Hydraulic connections	mm	20/27 male	26/34 male	20/27 male
Boiler connection	-	no	compatible	no
Electrical back-up (as standard)	kW	3	6 (3x2kW)	3
Decoupling of circuits		optional	yes	yes

*Only for the HTi⁷⁰ 11 and HTi⁷⁰ 14 heat pumps.



YOUR INSTALLER:

English
Version

MAY 2022 ISSUE

SALES

Rue de la République
80210 Feuquières-en-Vimeu - FRANCE
Tel. +33 (0)3 22 61 21 01
Fax. +33 (0)3 22 30 01 19
E-mail : adv@auer.fr

TRAINING

Tel. +33 (0)3 22 61 21 03
Fax. +33 (0)3 22 30 01 19
E-mail : formation@auer.fr

